

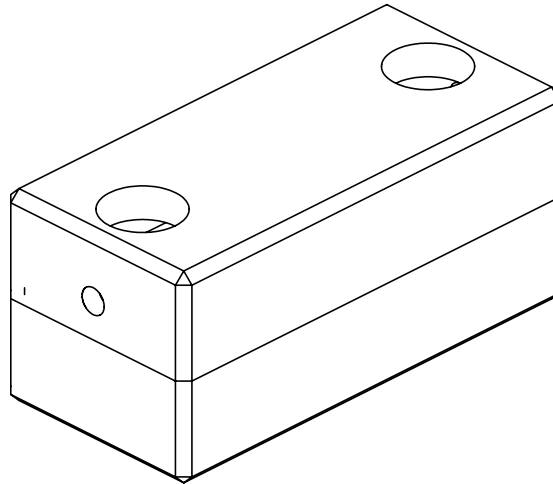

Concrete Systems Inc.
 9 Commercial St., Hudson, NH, 03051
 Phone 603-889-4163
 Fax 603-889-0039

4,500 Gallon Heavy Duty Tank Low Profile

Model# HT4.5KL



WEIGHT	
Top Section	Bottom Section
12.66	11.14
Total Weight	
23.81 Tons	

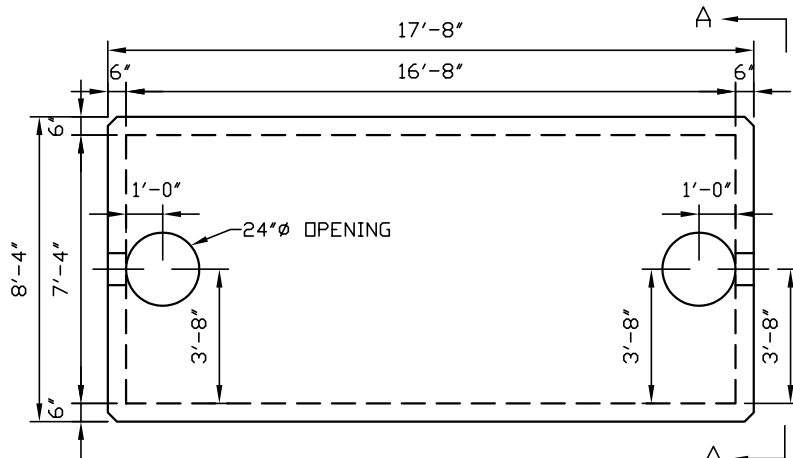

PLAN

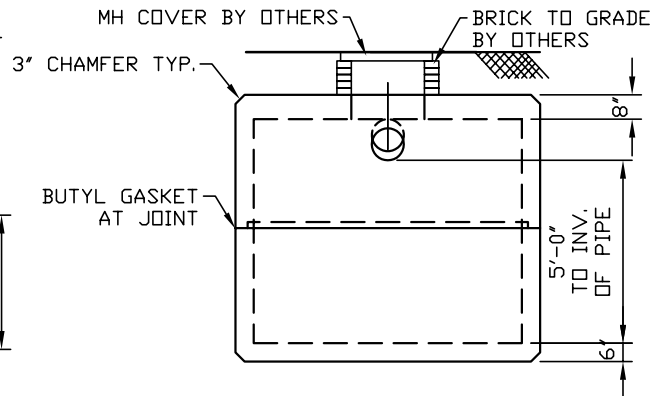

ELEVATION A-A

Design Parameters:

- Live load: HS20
- Earth Cover: 0 to 4'
- Concrete: Design strength $f_c = 5000$ psi
- Reinforcing: ASTM A615 (Rebar) Grade 60
- ASTM A185 (WWF) $f_y = 60,000$ psi